

**Title of Investigation:** MRI: Development of Cryogenic Infrared Spectrograph for the 1.6 Meter Solar Telescope in Big Bear

**Principal Investigator:** Roy Coulter (BBSO/NJIT)

**Co-Principal Investigators:** Matt Penn (NSO), Thomas Ayres (CU), Wenda Cao (BBSO/NJIT) and Philip Goode (BBSO/NJIT)

## Project Summary

Early in 2009 at Big Bear Solar Observatory (BBSO), first light engineering observations of the Sun were made with our 1.6 m clear aperture, off-axis telescope - the NST (New Solar Telescope). The NST will be the most capable, largest aperture solar telescope in the US until the 4 m off-axis ATST (Advanced Technology Solar Telescope) comes on-line in the middle of the next decade. Here we propose, in collaboration with Matt Penn of the National Solar Observatory (NSO) and Thomas Ayres of the University of Colorado (CU), to develop the Cryogenic InfraRed Spectrograph (CIRS) spanning 1.0 to 5.0  $\mu\text{m}$  for the NST. This system is essential for the NST to achieve its scientific potential of probing for the first time the fundamentals of the Sun's atmosphere with its dynamic magnetic field, the origin of space weather, while providing valuable experience and risk reduction for the ATST project. CIRS will be a substantial improvement over the two current solar IR spectrographs – one operating at the National Solar Observatory (on the McMath-Pierce telescope) and the other at Institute for Astronomy (Mees Solar Observatory, University of Hawaii), both of which are based on warm optics except for the detectors and order sorting filters. CIRS will be a significant advance, particularly for high-spatial and high-cadence and high Zeeman sensitivity observations of the Sun's atmosphere from the photosphere through the chromosphere, as well as observations of dimmer targets such as sunspot umbrae and off-limb features.

CIRS will be located on the NST at Big Bear Solar Observatory on Big Bear Lake in the San Bernardino mountains of California. CIRS is a complex cryostat. Construction of the dewar and the incorporated camera system will be handled by an outside vendor specializing in cryogenic instrumentation. BBSO personnel will be responsible for initial design and specification of the dewar and construction of the optical interfaces outside the dewar. These will include image stabilization hardware (correlation tracker), image control and positioning systems (image rotator and scanner), and overall opto-mechanical interfaces that interrupt the Coudé light path and feed light to CIRS. BBSO will perform the final integration of CIRS and will develop the control systems and data acquisition hardware and software.

Spectral observations of the photosphere and chromosphere utilizing the largely unexplored near-infrared (NIR) are crucial for solving many long-standing problems in solar astronomy, especially the disparity among of magnetic field measurements in visible and infrared spectral lines and the origin of the solar chromosphere. The infrared spectrum beyond 1  $\mu\text{m}$  is not only fertile ground for photospheric magnetic diagnostics, but also allows a unique window into the chromosphere lying atop the photosphere. The transition region between the near-equilibrium photosphere and solar corona is complex: the chromosphere is at once host to the coldest material in the whole solar atmosphere ( $T \sim 3500$  K, as seen in off-limb emissions of 4.6  $\mu\text{m}$  the carbon monoxide, CO, lines), and very hot gas ( $T \sim 10^4$  K, associated with ionizing shocks).

High spatial resolution polarimetry at NIR wavelengths requires large aperture telescopes. Here, we propose for funding to develop CIRS for the NST for observations at the Gregorian focal plane.

In sum, we directly address the two criteria required in an NSF proposal:

(1) Intellectual merit: CIRS will be the only fully cryogenic IR solar spectrograph, which will enable the NST to provide the community unique data on the solar magnetic field illuminating the fundamental character of our dynamic star, while probing the origins of space weather. Over the next decade, NSO will build and begin operating the ATST, the flagship telescope for the solar community. CIRS will be a significant testbed for the more complicated IR spectrograph(s) planned for the ATST. After the ATST is on-line, the NST will continue to be an essential telescope in making campaign-style observations.

(2) Broader Impact: The development of the proposed CIRS system continues our decade long tradition of training the next generation of scientists who build instruments. The resulting data will be used in many PhD theses. Our data will be open to the scientific community, and a substantial portion of observing time on the NST will be open to the community.

## A. Project Description

### A.1 Research Activities

#### A.1.1 Overview

Spectral observations of the photosphere and chromosphere utilizing the largely unexplored Near-InfraRed (NIR) are crucial for solving many outstanding problems in solar astronomy, especially the disparity among of magnetic field measurements in visible and infrared spectral lines and the origin of the solar chromosphere. In particular, high spatial resolution polarimetry at NIR wavelengths is essential and requires large aperture telescopes. Here, we propose for funding to implement the Cryogenic InfraRed Spectrograph (CIRS) operating from 1 to 5  $\mu\text{m}$  for the New Solar Telescope (NST) for observations at the Gregorian focal plane. First light engineering observations were made in January 2009 at Big Bear Solar Observatory (BBSO) with the new 1.6 m clear aperture, off-axis telescope - the NST. The NST development was largely funded by an NSF MRI grant (ATM-0320540), which began somewhat more than five years ago. The NST is just beginning its commissioning phase, and its development is described in some detail in Section A.2.1 since its light will feed CIRS. The NST will be the largest aperture solar telescope in the US, and perhaps the world, until the 4 m off-axis ATST (Advanced Technology Solar Telescope) comes on-line in the middle of the next decade. In addition to its tremendous scientific potential, the NST will be the testbed for many essential components and technologies of the ATST including CIRS. *Primarily we propose here, in collaboration with Matt Penn of the National Solar Observatory (NSO) and Thomas Ayres of the University of Colorado (CU), to build and utilize the CIRS, which is essential for the NST to reach its scientific potential.*

#### A.1.2 Scientific Motivation: Photospheric and Chromospheric Magnetic Fields

Many fundamental properties of our dynamic star will finally come within our grasp with the tip-tilt corrected IR light feeding CIRS from the Gregorian focus of the NST. IR data acquired at wavelengths beyond 1.5  $\mu\text{m}$  will be invaluable in addressing key problems of solar physics.

#### A.1.2.1. Magnetic Fields in the Photosphere

Observations of weak magnetic fields in the solar photosphere using absorption lines in the visible spectrum suggest that much of the magnetic flux is concentrated in kilo-Gauss magnetic fields existing in the quiet Sun (Tsuneta et al., 2008; Lites et al., 2008), and the observed weak flux may be a result of the low spatial filling-factor that characterize these fields (e.g. Stenflo 1993). However, when measurements of these fields are made with the more sensitive 1565 nm Fe I (Landé g-factor,  $g_{\text{eff}} = 3$ ) absorption line, a different picture emerged. A distribution of weak magnetic field strengths was seen (Rabin, 1992; Lin 1995), which contradicts the observations made at visible wavelengths. It has been suggested that thermal effects in some visible lines combined with their weaker Zeeman splitting have produced erroneous measurements, and that the field strength distribution measured by the infrared lines is more representative of the true solar magnetic fields (Collados, 2005).

New observations using more sensitive spectral probes of the weak solar magnetic field can help to resolve this problem. A set of Fe I and Si I lines are seen in the photosphere in the reference atlas from Wallace and Livingston (2003) between 3695 and 4150 nm. A Si I and an Fe I line near 4060 nm both have  $g_{\text{eff}} = 1.25$ ; this makes them slightly more magnetically sensitive than the 1565 nm Fe I line (an 8% advantage), see Table 1. Alan Clark has observed the intensity spectra of several spectral lines from Si I near 4137 nm, which do not have their transitions listed by Kurucz (Kurucz and Bell, 1995); from intensity spectra he saw these lines showing large Zeeman splitting, suggesting that they are much more sensitive than the 1565 nm line (by more than 50%). Han Uitenbroek lists only two possible transitions for the Si I line at 4142.5 nm, and the line should have  $g_{\text{eff}} = 1.625$  or  $g_{\text{eff}} = 2.25$ . This means that this line is either 40% or 98% more magnetically sensitive (see Table 1) than the 1565 nm line, and will provide a sensitive measurement of weak solar magnetic fields. Within sunspot umbra, currently the most sensitive line known is the Ti 2231 nm line. Some initial work has been done with this line (Ruedi et al., 1998, Penn et al., 2003) and the  $g_{\text{eff}} = 2.5$  value makes this line 18% more sensitive than the Fe I 1565 nm line. This Si I line at 4142.5 nm will provide an even more sensitive probe of sunspot magnetic fields.

Table 1: IR Bands of Interest for CIRS Magnetic Field Measurements.

Region	Species	$\lambda$ [nm]	$g_{\text{eff}}$	Mag Sensitivity $\lambda g_{\text{eff}}$
Photosphere	Fe I	1565	3	4695
	Ti I (spots only)	2231	2.5	5578
	Fe I	4063.7	1.25	5080
	Si I	4142.5	(1.625 or 2.25)	(6732 or 9321)
Chromosphere	Ca I	854.2	1.0	854
	Ca I	3697.4	1.1	4067
	Mg I	3681.6	1.17	4307

The importance of weak magnetic fields was pointed out in Stenflo (1993): the flux in this weak field component is comparable to the strong-field flux and therefore the role of weak fields in the solar dynamic processes should not be underestimated since the emergence rate is two orders of magnitude larger than that of active regions. Not only will new measurements of this 4142 nm Si I line address weak fields in the solar photosphere, but they also will provide the most accurate photospheric measurements possible needed to address such problems as i) the dynamics of the magnetic field in the photosphere; ii) injection of twist in the solar atmosphere (and related questions of energy build-up); and iii) coronal heating processes.

#### A.1.2.2. Magnetic Fields in the Chromosphere

Recent work measuring the magnetic fields in the solar chromosphere using the 854.2 nm Ca I line have produced intriguing results regarding the magnetic canopy, and also show interesting effects in filament channels (Harvey et al., 2003). A promising chromospheric line in this spectral region is the Mg I line at 3681.6 nm. With a  $g_{\text{eff}} = 1.17$ , this line is 5 times more sensitive to Zeeman splitting than the 854.2 nm line. With the gain in magnetic sensitivity provided at these longer wavelengths, a new realm of sensitive chromospheric magnetic measurements will be possible when these lines are used.

One of the many advantages of chromospheric magnetic field measurements is related to their height of formation. Various force-free extrapolation models assume that the photospheric field (used as a boundary condition) is force-free, which is rather a gross simplification in case of visible magnetograph lines

such as Fe I 630.2 nm. The magnetic field becomes force free only when the plasma  $\beta$  (gas pressure divided by magnetic pressure) is of order  $10^{-1}$ , which occurs in the chromosphere. Thus, observations in IR chromospheric lines will provide measurements consistent with force-free models, which will inevitably improve our ability to model coronal magnetic fields above active regions, and in the heliosphere.

CIRS will be a substantial improvement over the two current solar IR spectrographs – one operating at the National Solar Observatory (on the McMath-Pierce telescope) and the other at Institute for Astronomy (Mees Solar Observatory, University of Hawaii), both of which are based on warm optics except for the detectors and order sorting filters. CIRS will be a significant advance, particularly for high-spatial and high-cadence and high Zeeman sensitivity observations of the Sun’s atmosphere from the photosphere through the chromosphere, as well as observations of dimmer targets such as sunspot umbrae and off-limb features. As one of the planned ATST focal plane instruments, the NIR Spectro-Polarimeter (NIRSP), operating in the 1-5  $\mu\text{m}$  range, will be developed by NSO. This system will be configured at the Gregorian focus (NIRSP-G) and coudé focus (NIRSP-C) to provide coronal spectroscopy and photospheric spectropolarimetry. In addition, the Thermal IR Polarimeter (TIPS) is being considered as one of the downstream, operational phase instruments. TIPS will cover the entire thermal range from 5  $\mu\text{m}$  out to the long wavelength cutoff at about 28  $\mu\text{m}$ . Without a doubt, CIRS will be a significant testbed for these more complicated IR spectrographs planned for the ATST.

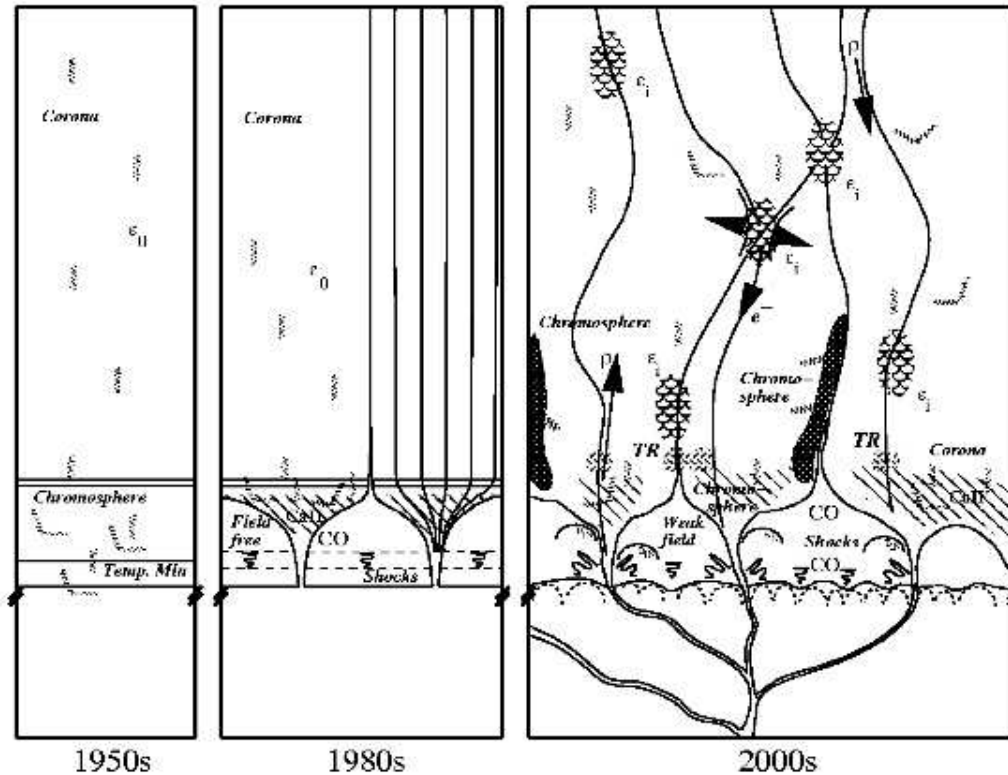

Figure 1: Cartoon of evolution of thinking concerning the solar chromosphere (C. J. Schrijver). It has grown from a simple ‘layer’ of the 1970’s; to topologically more diverse view of the 1980’s, mixing cool (“CO”) and hot gas at similar high altitudes, although still largely static; to contemporary highly dynamic and spatially chaotic “Magnetic Complexity Zone.” This messy region now is speculated to be the main power source of the overlying corona, rather than the historical view in which coronal “tail” to some extent wagged the chromospheric “dog.”

### A.1.2.3. Structure of the Chromospheric in the IR

The infrared spectrum beyond  $1 \mu\text{m}$  not only is fertile ground for photospheric magnetic diagnostics, but also allows a unique window into the chromosphere lying atop of photosphere. The transition region between the near equilibrium photosphere and solar corona is complex: the chromosphere is at once host to the coldest material in the whole solar atmosphere  $T \sim 3500 \text{ K}$ , as seen in off-limb emissions of  $4.6 \mu\text{m}$  the carbon monoxide, CO, lines), and very hot gas ( $T \sim 10^4 \text{ K}$ , associated with ionizing shocks).

Chromospheric models (Ayres and Rabin 1996 and references therein) based on the CO vibration-rotation spectral band show that below a 1000 km, over most of the solar surface, most of the time, there is no chromosphere: most of the volume below the magnetic canopy is occupied by a region that is cooler than the temperature minimum of standard models.

The CO molecular band is a uniquely suitable probe

of the transition from the photosphere to the outer atmosphere, mostly because they strongly dissociate at temperatures in excess of 4000 K. The band lines are formed closely in LTE and they have narrow contribution functions.

The molecular observations to date have made progress in directly imaging the strangeness of the chromosphere, see Figure 1. A major thrust of contemporary solar (and stellar) physics is to dig deeper into this enigmatic chromosphere, in an effort to understand its role in energy transport and atmospheric heating, and as a reservoir of mass and energy to feed the overlying corona (whose heating and mass loading requirements are but a small fraction of those of the chromosphere itself).

The recent advances in IR sensors, spectrographs, optical multiplexing technology (“image slicers”), and adaptive optics, embodied in the proposed CIRS for the NST, will finally enable the full-fledged thermodynamic mapping studies that a number of groups

Table 2: CIRS Initial Scientific Programs.

Senior Personnel in Alphabetical Order	Project
Thomas Ayres	4.6 $\mu\text{m}$ studies of the COmosphere
Wenda Cao	Distribution of B-fields in Quiet Sun
Philip Goode	Relative Properties of Fibril Fields in Photosphere and Chromosphere
Valentyna Abramenko, Vasyl Yurchyshyn and Goode	Flux Emergence and Space Weather
Aleksandra Andic and Goode	Photospheric and Chromospheric Oscillations
Matt Penn	Studies of Photospheric and Chromospheric B-Fields
Graduate Student(s)	Work with Instrument and Science Teams

have been conducting in a prototype way for the past decade (e.g., Uitenbroek, Noyes, & Rabin, 1994; Ayres & Rabin, 1996; Ayres, Plymate, & Keller, 2006). One obtains ‘movies’ of temperature (from CO line depths) and line-of-sight velocity (Doppler shifts) over a patch of the solar surface by repetitively stepping the image across the slit of the spectrometer (or, by means of an image slicer over a smaller field of view). The CO 4.6  $\mu\text{m}$  lines arise at relatively high altitudes, thanks to the preference of the molecular chemistry for cooler temperatures; and their formation very close to LTE, a helpful property of molecular rovibrational lines in general. Visible atomic lines strong enough to arise at high altitudes commonly are affected by NLTE formation, which sharply diminishes their value as thermodynamic tracers.

In addition to probing conditions in the upper photosphere, the CO bands can reach into the low chromosphere by exploiting the fact that they go into “emission” above the solar limb (actually, the line cores are radiating at relatively low temperatures,  $\sim 3500$  K, but the surrounding continuum fades away above the limb, leaving only the optically thick CO to radiate). The physical properties of the COmosphere alluded to previously—especially, how much of the chromospheric volume it occupies—still are largely unknown, and this is mainly due to the relatively primitive state of contemporary IR observations.

The versatile CO lines also are excellent probes of thermodynamic structure in, and around, cool sunspot umbrae; although progress in this area has been hampered again by lack of IR spectroscopic capabilities (not to mention the simple lack of sunspots during the

past few years during the minimum of cycle 23).

Keys to exploiting the CO bands in practice are: (1) high spatial resolution ( $< 1''$ ); (2) high spectral resolution ( $> 100,000$ ); (3) low scattered light (in the off-axis NST optics as well as in the spectrograph); and (4) good sensitivity (for fast scanning). High spatial resolution and good sensitivity imply a large telescope aperture, like that of the NST; and low scattered light implies a modern, off-axis telescope design, again like the NST.

CIRS will be used by BBSO scientists (Goode, Cao, Abramenko, Yurchyshyn and Andic) in collaboration with Ayres and Penn to attack the scientific problems discussed in this section. Some initial topics are listed in Table 2.

## A.2 Description of Research Instrumentation and Needs

### A.2.1 Schematic of the NST

BBSO has removed its old 0.6 m aperture telescope (donated to the Los Angeles Amateur Astronomy Society) and the alignment of the modern, off-axis 1.6 m clear aperture instrument (Goode et al., 2003) has been finished and first engineering light has been attained at the Nasmyth focus. CIRS will have a slightly different light feed. The telescope has been run for several days tracking the Sun with full sunlight on the heat stop and images of granulation obtained at the Nasmyth under winter seeing conditions. The new telescope offers a significant improvement in ground-based high angular resolution capabilities, and will substantially enhance our efforts to understand as-



Figure 2: The NST mirror cell (lower left), secondary mirror on hexapod (upper middle), M3 complex with wavefront sensing system (lower right), one counterweight for right ascension balance (extreme right), and aperture shade (middle top).

pects of the photosphere and chromosphere that are best revealed by NIR spectroscopy, as detailed in Section A.1.2. The NST project is described in detail in <http://www.bbso.njit.edu/newtelescope>.

The NST is configured as an off-axis Gregorian system consisting of a parabolic primary, prime focus field stop and heat reflector (heat-stop), elliptical secondary and diagonal flats, see Figures 2 and 3. The primary mirror (PM) is 1.7 m with a clear aperture of 1.6 m. The PM was figured to a final figure residual error of 16 nm rms by Steward Observatory Mirror Lab. The focal ratio of the PM is  $f/2.4$ , and the final ratio is  $f/50$ . The  $180''$  circular opening in the field stop defines a  $120'' \times 120''$  maximal square field of view (FOV) of the NST. This field is re-imaged by the secondary forming the Gregorian focus about 5 me-

ters distant. The light is folded through the Declination axis and then either directed by the coudé mirror down the polar axle or allowed to pass on through the Declination axle to the Nasmyth Bench. The working wavelength range will cover 0.4 to  $1.7 \mu\text{m}$  in the Coudé Laboratory two floors beneath the telescope, and all wavelengths including far infrared at the Nasmyth focus on an optical bench attached to the side of the telescope structure. Here we are proposing for a spectrograph at the feed from the Gregorian focal plane along the path to the Coudé Laboratory. NST's off-axis design was chosen principally because of its vastly reduced stray light, since there is no central obscuration, which reduces the telescope's MTF (Modulation Transfer Function) at high spatial frequency.

We have designed an open telescope structure with

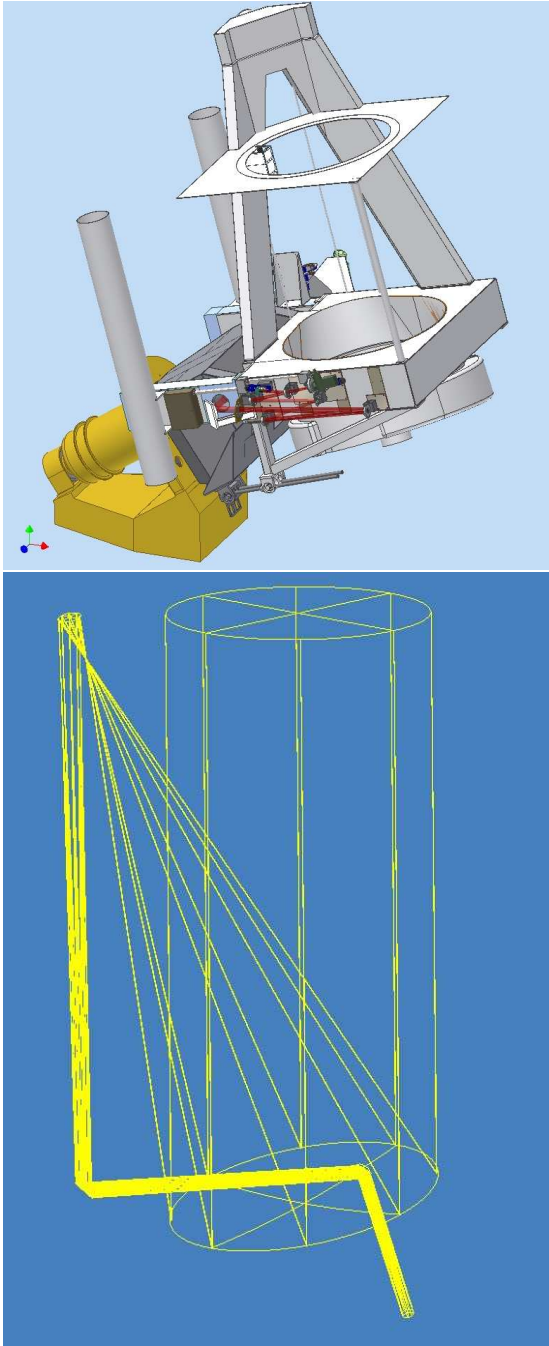

Figure 3: Schematic of the 1.6 m off-axis, open NST (top) and its optical layout (bottom). On the top part, the heat stop (HS) resides at the prime focus with the SM mounted on a PI hexapod. The wavefront sensing system (WFS) resides immediately before M3. M4 is mounted on the telescope fork and sends the light to the Coudé Room below. The HS, SM, M3 and M4 are not apparent in the figure. If M4 is flipped out the light goes to the Nasmyth Bench for which the light path is shown in red. This is where the first light observations occurred. The design was driven by competing needs for rigidity near the SM and an open light path. For more details, see <http://www.bbso.njit.edu/newtelescope>.

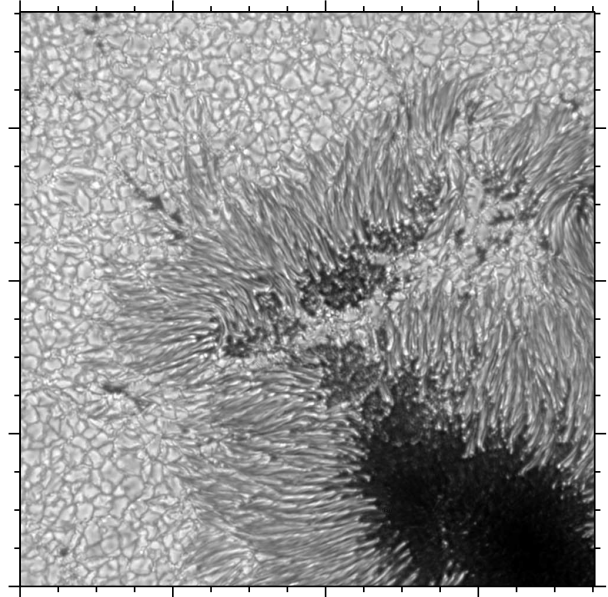

Figure 4: A diffraction-limited image obtained from the old 65 cm BBSO telescope, which serves to demonstrate the quality of the site.

an equatorial mount, as illustrated in Figure 2. A key design issue for a large aperture, solar telescope is the thermal control system to keep the temperature of the mirrors very close to, or even slightly below that of the ambient air. The dome employs a wind-gate and exhaust system to control the airflow from the wind helping to maintain the same temperature inside and outside the dome, and remove concentrations of heat in and around the optical paths. In fact, we have measured the temperatures along the optical path from the telescope to the Coudé Laboratory (which is thermally controlled to 0.5 K). When the vent gates and exhaust system are turned on, the temperature all along the optical path becomes precisely uniform. In addition, we have implemented a closed cycle, chilled air system as part of the OSS (Optical Support Structure) to limit so-called “mirror seeing” by sweeping away turbulent cells and directly cooling the PM. What matters for CIRS is the feed to the Coudé Lab, which also has an isothermal light path. The OSS and active support mirror cell were built and tested by DFM, Engineering in Longmont, CO. The PM is supported by 36 actuators that can bend out low-order aberrations, such as those due to gravity and/or thermal effects. Its shape will be controlled by a wavefront sensing system (<http://www.wavefrontsciences.com>), which resides immediately before M3. First light en-



engineering observations of the Sun have been made at the Nasmyth focus, and granulation is apparent. There is still a few weeks effort before we surpass images from the old telescope, as shown in Figure 4. Still, the commissioning phase of the NST has begun, and scientific observations at the Nasmyth will long precede the beginning of the work proposed here.

The new, larger dome, required to house the NST, is fully operational and the installed telescope is shown in Figure 2. The elliptical secondary mirror (SM) was silvered, and was been tested by both SORL (Space Optics Research, which figured the SM) and Steward before its installation on the NST PI hexapod. The NST telescope control system (BBSO-TCS) has been developed by BBSO staff over the past several years. The TCS supplied by DFM Engineering is used for low level control of the telescope pointing and some on-board systems. The more complex BBSO-TCS is now operational and controls all telescope functions, on-board systems, and the dome. BBSO-TCS orchestrates the M2 hexapod, wavefront sensor, PM actuators, several Galil motion controllers, and the DFM-TCS. In addition, camera controls and data acquisition systems have been developed to obtain images from the Nasmyth Bench. The next step will be to bring the Correlation Tracker (CT) online. This will supply stabilized images to the Nasmyth cameras. This CT technology will be used in the feed optics to CIRS.

### A.2.2 Strehl Ratio of the Beam Feeding the Spectrograph

Ideally, we would like CIRS to be fed with diffraction limited light over the entire 1.0-5.0  $\mu\text{m}$  range of operation. This spectral range does not require full adaptive optics correction because the terrestrial atmosphere is less turbulent in the IR than in the visible, so tip-tilt corrections alone are sufficient for most observations. Given the seeing at BBSO and the limitations of tip-tilt corrections, the diffraction limit will almost never be achieved at 1.0  $\mu\text{m}$ , while for wavelengths beyond 2.5  $\mu\text{m}$ , diffraction limited observations will be the norm.

The Strehl, generally used to quantify the performance of an adaptive optics (AO) system, is the ratio of the maximum intensity in the corrected image in the detector plane to that from a theoretical, perfect imaging system operating at the diffraction limit. Experience, at the NSO at Sacramento Peak (NSO/SP) and

elsewhere, from existing solar AO systems as well as detailed performance modeling of corrected observations using MHD simulations of solar magnetic fields show that a Strehl of  $S \geq 0.3$  is required to perform the desired quantitative analysis of the small-scale magnetic elements. So, under what circumstances will this Strehl be achieved for light fed to our planned spectrograph by a tip-tilt system?

A simple way of quantifying the image quality after tip-tilt correction is by computing the residual wavefront error variance,  $\sigma^2 = 0.134(D/r_0)^{\frac{5}{3}}$ . From this, we can calculate the Strehl of a long exposure image in the usual Marechal approximation (for more detailed discussion see Christou et al., 2006a, and Christou et al., 2006b and references therein), where  $S = e^{-\sigma^2}$ . Further,  $D$  and  $r_0$  are the telescope aperture diameter and  $r_0$  is the Fried parameter. Often, the Fried parameter is used to quantify the seeing conditions at a site.  $r_0$  is the coherence length of the atmospheric turbulence. Without image correction, for telescope apertures larger than  $r_0$ , resolution is seeing limited. The Fried parameter is wavelength dependent ( $r_0 \propto \lambda^{\frac{6}{5}}$  for the generally-assumed Kolmogorov turbulence). The BBSO site has been well-studied within the ATST site survey (see <http://atst.nso.edu/site> for details). Over the two years of seeing measurements, BBSO has been shown to be characterized by steady seeing all day long with an average of Fried parameter of about 6.5 cm for light of  $\lambda = 0.5\mu\text{m}$ . About one-quarter of the time,  $r_0 \geq 10$  cm all day long. The origin for the steady, good seeing is the well-documented lack of ground-level atmospheric turbulence, which is the result of the NST dome being located in the middle of Big Bear Lake. The lake is almost always cooler than the air and, thus, provides a natural inversion that suppresses the turbulence during our typical observing conditions in which a constant wind comes from the west over two miles of open lake water.

Using the Marechal approximation and assuming  $r_0 \sim 10$  cm at  $\lambda = 0.5\mu\text{m}$  in all cases in this paragraph, we calculate that at 1  $\mu\text{m}$   $r_0 \sim 25$  cm, and we have  $S = 0.03$ , which means we are seeing limited with a seeing disk of about  $0''.5$ . At 1.6  $\mu\text{m}$ , where the Sun has its opacity minimum and there are strong magnetic lines, we have  $r_0 \sim 40$  cm and a tip-tilt corrected  $S = 0.26$ , which is close to the 0.3 that experience has taught us is sufficient for diffraction limited imaging that would be  $0''.20$  at 1.6  $\mu\text{m}$  for the spectrograph.

At  $2.5 \mu\text{m}$ ,  $r_0 \sim 70 \text{ cm}$  and  $S \sim 0.7$ . For all wavelengths red of  $2.5 \mu\text{m}$ , even the everyday seeing, after tip-tilt correction, is sufficient to feed diffraction limited light to the spectrograph. In general, we plan to use our real-time speckle reconstruction system as a daily guide to the best wavelengths to observe with the spectrograph. Some particular wavelengths of interest in the  $1\text{-}5 \mu\text{m}$  band are listed in Table 1, along with their significant properties and the science tasks that can be attacked with the spectrograph.

### A.2.3 Zeeman Splitting in the NIR

Another advantage at longer-than-visible wavelengths is the appreciably greater Zeeman splitting, which enables us to separate the true magnetic field strength and filling factor from the magnetic flux that is measured in the visible.

Observations in the NIR benefit from the fact that the Zeeman splitting increases quadratically with wavelength. Observations in that regime are vital for measurements of weak magnetic field strengths. In that way, visible and NIR observations complement each other because the former gives us higher resolution and the latter gives a better separation of magnetic flux into field strength and filling factor.

The Zeeman splitting,  $\delta\lambda$ , is given by  $\delta\lambda \propto g_{\text{eff}}B\lambda^2$ , or more typically the fractional Zeeman splitting  $\delta\lambda/\lambda \propto g_{\text{eff}}B/\lambda = \lambda(g_{\text{eff}}B)$ , where  $\lambda$  is the wavelength,  $g_{\text{eff}}$  is the Landé  $g_{\text{eff}}$ -factor and  $B$  is the magnetic field strength. Further,  $(g_{\text{eff}}B)$  is called the ‘‘Magnetic Sensitivity’’ for purposes of comparing the utility of various IR lines.

### A.2.4 The CIRS Development Plan

The CIRS is a complex cryostat, and construction of the dewar and the incorporated camera system will be handled by an outside vendor (IR Labs) specializing in cryogenic instrumentation. BBSO and CIRS proposal personnel, as well as Don Mickey (designer of the IR solar spectrograph at the University of Hawaii) and IR Labs personnel were responsible for the initial design and specification of the dewar and the optical interfaces outside the dewar. These will include the image stabilization hardware (correlation tracker), image control and positioning systems (image rotator and scanner), and the overall opto-mechanical interfaces that interrupt the Coudé light path and feed light

to CIRS. After funding, this team will make, and then review the final design, and this design will be subsequently reviewed by other outside experts (such as William Livingston and Haosheng Lin). After construction, BBSO will perform the final integration of CIRS and will develop the control systems and data acquisition hardware and software.

Design of the CIRS and its support optics will be finalized and externally reviewed within the first six months of the project. Once the Critical Design Review is completed, the work will be able to proceed in parallel on three fronts:

1) IR Labs Inc. of Tucson AZ will be contracted to assist with final design, fabrication and implementation of the dewar, building and installing the various cryo-mechanisms, and providing a turn-key IR camera system with the sensor integrated in the dewar. This is part of the standard instrument development that they offer. The integrated camera system is a unique product that will save a lot of design and development at BBSO, trimming cost and about one year off the project.

2) BBSO will proceed with development of the optical path to CIRS and integrate the support structures required into the standard optical path to the Coudé Laboratory. The interface to CIRS will be installed as a place holder during the refurbishing of the Coudé Lab’s Adaptive Optics system. This will allow Coudé Lab observations to proceed with minimal interruption during the installation and ‘static’ testing of CIRS.

3) At the same time, BBSO will proceed with CIRS control system development along with the fabrication and testing of the various moving systems requiring machine control in the optical path external to the dewar.

Once these tasks are completed and the dewar system has been delivered, the BBSO team will integrate the external optical bench and dewar, install internal optical elements and proceed with testing of the overall system. The initial work will be done in our on-shore laboratories and all but final testing can be accomplished with a warm dewar. This will minimize the testing required once CIRS is installed at the telescope.

After bench tests in BBSO laboratories are complete and the instrument is certified as operational, CIRS will be transported to the telescope and installed

on the third floor along with its control system and cryo-compressor, as illustrated in Figure 5. This move will require a crane to lift the dewar and bench into position and will likely mean that most of its optics will have to be disassembled for safety and reinstalled at the telescope.

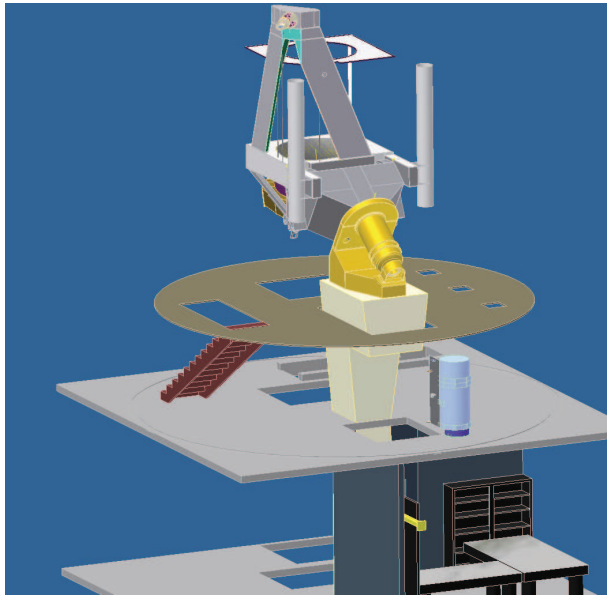

Figure 5: A cutaway sketch of CIRS location with respect to NST and Coudé Lab. The CIRS volume is represented by the blue cylinder and is located on the concrete floor above the Coudé Lab.

### A.2.5 The Opto-Mechanical Design of CIRS

A baseline concept has been developed for CIRS with sufficient detail to confirm good optical performance across the desired wavelength band of 1 to 5  $\mu\text{m}$  and identify feasible locations for the dewar and fore-optics, see Figure 6 and 7. CIRS is configured as an out-of-plane Ebert design using a 79 line/mm grating at an f-number of 2340. The theoretical resolving power of the spectrograph is proportional to the grating width and inversely proportional to the slit width. CIRS will use the widest grating commercially available to meet its resolution criteria. The grating is also a custom length to allow clearance for light paths within the dewar but is readily available from Newport Optics. The slit width is set to 1/2 the Rayleigh criterion to properly sample the NST image. Thus, the resolving power decreases with increasing wavelength (and increasing slit width) resulting in a large

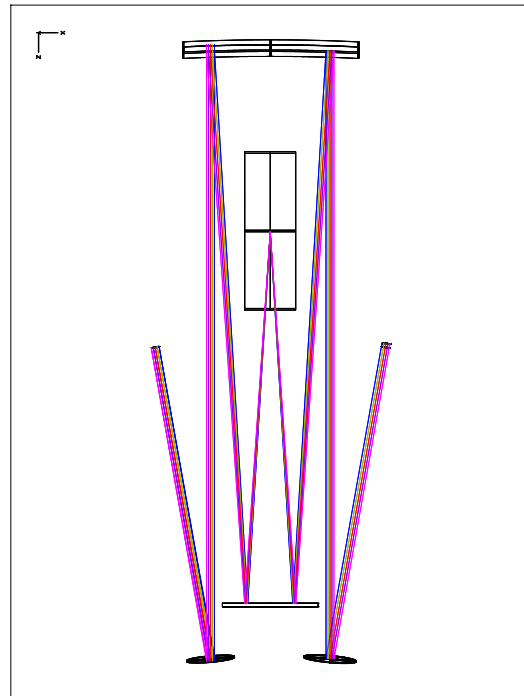

Figure 6: Schematic of the CIRS optical path. The path is symmetric with incoming light, say, on the left and the camera on the right side end of the optical path. In sequence, the light is reflected from a flat mirror, then a collimating mirror, then a flat and into the grating (represented by the rectangle at the center of the figure). The light path is folded twice on either side of the grating to reduce the length of the instrument. The custom size grating allows the light to pass by.

variation over the design bandpass as shown in Figure 8.

Light enters CIRS through a side window in the dewar, is folded to run lengthwise and intercepted by the slit. There will be a series of eight slit-filter combinations housed in a rotating wheel. The image formed at the slit is 100" in diameter and the slit height will be 20 mm. The slit structures and filters will be a standard 25 mm diameter. Each slit will be sized to half the diffraction limit at the wavelength of interest and paired with the appropriate order blocking filter in the wheel. All moving elements within the dewar will be powered by external motors via standard vacuum feedthroughs. There will be no slit viewing camera but context images can be obtained from the Correla-

tion Tracker camera in the fore-optics module.

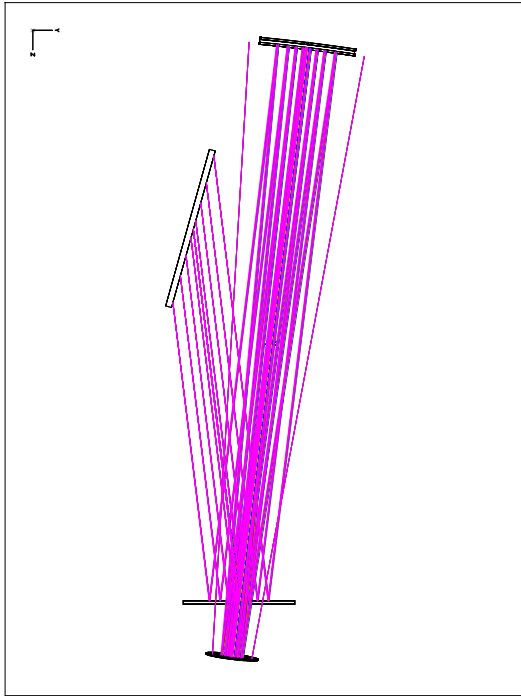

Figure 7: Schematic of CIRS, like Figure 6, but now showing the out-of-plane character of the instrument. The grating (upper left) is located above the slit-collimator-detector plane to allow space for the grating rotation mechanism. The incoming light path is not evident in this view but it lies in the plane between the collimator (at the top of the figure) and the small folding mirror at the bottom.

Beyond the slit the light will be folded back, passing by the slit mechanism to reach the collimator. The collimator is a standard parabola tilted slightly to move the beam out-of-plane and onto the grating. This allows space for the grating rotation mechanism outside the crossing light paths. In the Ebert design, the same parabola is used as the collimator and the focusing element for the detector. This simplifies the spectrograph alignment but presents a challenge for masking the unused portions of the parabola and requires careful attention to scattered light control. The more general Czerny-Turner design which uses two off-axis parabolic elements would also be suitable for the CIRS configuration. The immediate post-funding design work will also examine the trades between these two designs. In either case the light emerg-

ing from the grating is folded again to run lengthwise through the dewar and to shift the beam to the open area opposite the filter wheel where the detector will be mounted on a focus stage. The detector is an InSb 1024x1024 array produced by Raytheon in California. IR Labs produces a standard turn-key system that can operate this array at 30 frames/second. The camera will be integrated into the dewar by IR Labs. The optical performance of CIRS is illustrated by the spot diagram in Figure 9. CIRS will be diffraction limited beyond  $2 \mu\text{m}$ .

Light from the 1.6 meter telescope can be directed down the polar axle and transfer optics send the light to the Coudé Lab two floors below the telescope. The CIRS all-reflecting, fore-optics will intercept the light as it exits the polar axle and redirect it to the spectrograph. Since the Gregorian focus occurs inside the axle, a set of transfer optics ( a pair of parabolic mirrors ) will be required to place the image in range of the correlation tracker (CT) subsystem. These transfer optics will be moved in and out of the light path on a linear motion stage mounted at the back of the telescope pedestal. In the CT subsystem a collimating mirror will form a small pupil image on an active mirror that corrects tilt in the incoming wavefront. The system uses a high speed camera and computer to measure the incoming wavefront and send drive signals to the mirror stage correcting image motion. This is identical to the system already developed for the NST's Nasmyth focus. The two systems will be able to share the CT camera and active mirror systems, which will reduce development cost because it is already a sunk-cost for the Nasmyth Bench. Beyond the CT system a rotating K-mirror will be used to set the image position at the slit allowing precise angular location of solar features. In addition the K-mirror will cancel the image rotation caused by the coudé feed mirror on the polar axle. At the entrance window of the dewar a pair of folding mirrors on a linear stage will be used to scan the image across the slit so a 2-dimensional region can be observed. The CIRS dewar and its detector will be maintained at 70-50 Kelvin by means of closed cycle cryo-coolers reducing the thermal background emitted by the spectrograph's optical elements. The cryogenic nature of CIRS means a much improved signal-to-noise performance over existing systems, and this improvement increases in significance with altitude as the thermal

background becomes more competitive with the signal. The slit wheel and slit substrate will provide a good cold mask to eliminate most scatter from the warm elements upstream of the dewar. This will be a substantial improvement over current solar IR spectrographs operating at NSO (on McMath-Pierce telescope) and Institute for Astronomy (Mees Solar Observatory, University of Hawaii), which are based on warm optics except for the detectors and order sorting filters. This will be a significant advantage particularly for observations of dimmer targets such as sunspot umbrae and off-limb features.

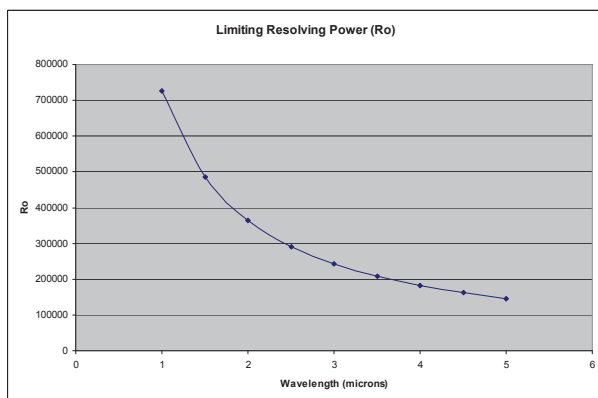

Figure 8: The limiting resolving power of CIRS is plotted v.s. wavelength. Although the actual resolution will be about 2% less than this value, CIRS will meet the design goal for  $R > 100,000$  at  $4.7 \mu\text{m}$ .

### A.2.6 Control Systems

CIRS will have a number of moving sub-systems and will require sophisticated machine control. The NST project has standardized on Galil motion controllers for all ancillary telescope instrumentation and we will continue that mature tradition with CIRS. Each Galil motor controller is capable of running control sequences with onboard firmware. Programming is written in an easy to learn mnemonic language and downloaded to the controller. Standard library functions as well as custom coding can be executed via ethernet. The team is already quite familiar with this control method and can quickly bring the systems on-line. We will use at least two motion controllers, likely having one dedicated to the dewar systems and one the Fore-Optics module.

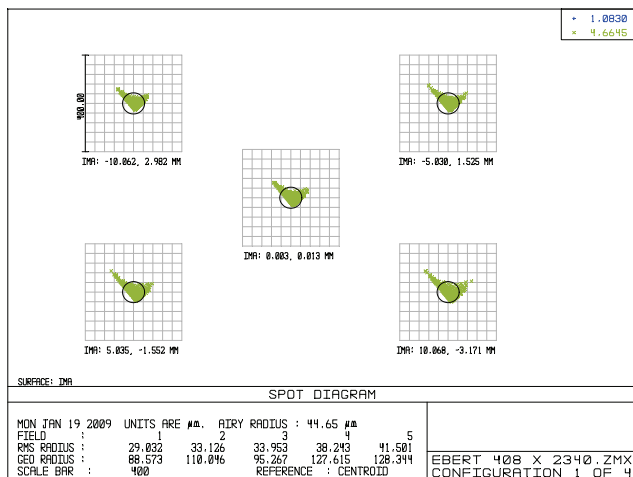

Figure 9: Spot diagram for CIRS for performance at  $1.0$  and  $4.6 \mu\text{m}$ . The green spots show diffraction limited performance at  $4.6 \mu\text{m}$ . The circle represents the Airy disk at  $4.6 \mu\text{m}$ . The blue would show a tiny spot and a tiny Airy radius for  $1.0 \mu\text{m}$ , but the spot is not apparent and the performance would not be quite diffraction limited. However, the performance would be diffraction limited beyond  $2 \mu\text{m}$ .

### A.3 Impact on Research and Training Infrastructure

Designing, building and implementing CIRS on the NST is a unique opportunity for BBSO and the solar community. The CIRS Project will design and implement a unique and valuable instrument on the NST, which is unique by itself. The instrument will enable much significant science and lay the ground work for next generation solar instrumentation, like the ATST and its NIR spectrograph(s). The people participating in the CIRS project are at the vanguard of the new generation of solar astronomy. Even though this project does not directly support a PhD student or postdoctoral associate, they will be involved.

Over the ten years that NJIT has run BBSO, eight former students/postdocs have moved on to tenure track (or tenured) positions at universities or national centers. This includes two women. We carefully mentor our junior people at BBSO. We do this by carefully integrating each into the research and/or instrumentation teams to broaden experience while maximizing intellectual productivity. We have a video conferencing center on site in Big Bear, so we can have joint

seminars and enable classroom teaching from NJIT to BBSO, and vice versa. When ready, postdocs are encouraged to get involved in proposal writing, but great care is taken to keep this effort at a productive level, while not interfering the person's research efforts.

### **A.3.1 Education, Research Training and Mentoring**

NJIT has a diverse student body in an urban environment, with a large minority student population. BBSO highly prizes its special role in the education of the next generation of scientists who build instruments. We currently have six PhD students, including one US citizen, who will receive PhD's from NJIT in various fields: applied physics, electrical and computer engineering, and computer science. The very best NJIT students are attracted to the BBSO program. The typical student designs and builds the instruments used to make his/her PhD measurements in BBSO, although this is not possible for the CIRS Project.

Two PhD student(s) will be involved in this project. However, they will be funded by BBSO's five-year NSF-ATM backbone grant and Cao's NSF Career Award. We believe that this project will be a strong draw for talented NJIT students who are already interested in instrument development. The graduate student will be trained in spectrograph design, and will also assist with the set-up, observation and data analysis. In addition, BBSO typically has 1-2 undergraduates who spend the summer at BBSO, as well as working on BBSO projects during the school year. The NST will also become a teaching tool for optics, mechanics, computer control and solar physics. As well, a postdoctoral associate, Dr. Aleksandra Andic will be involved in the project, by doing image processing and as a user of CIRS. She is supported by other funds.

### **A.3.2 Data and Telescope Time**

Since NJIT began operating BBSO, its telescope time and data have been open to the community. Many scientists have had observing time. Further, several PhD students from around the world have used BBSO data as a central part of their work on their theses. Data requests come to BBSO on a daily basis from around the world. We are an active participant in the Virtual Solar Observatory (VSO). Users of our telescopes and

data are only asked to acknowledge BBSO in their resulting publications. Many observers have used our data to help plan their observing campaigns.

The observing time of the first, next generation solar telescope in the US, the NST, will be oversubscribed because of its much improved scientific capability compared to the old 0.6 m telescope. We will continue our open observing time and open data policies. We plan to make a portion of observing time available to the community. The Telescope Allocation Committee will rank the proposals and allocate time.

## **A.4 Management Plan**

Roy Coulter is the key co-PI on the CIRS Project. He has a quarter-century experience in all aspects of hardware design, development, implementation and testing for solar observatories. He is the Director of the NST project and has designed the CIRS spectrograph. Before his successful effort on the NST, he was the Project Engineer for the off-axis SOLAR-C telescope at the University of Hawaii. His experience as Design Engineer for the AEOS Infrared Spectrograph responsible for radiation shields and closed-cycle cryocooler systems is germane to CIRS. PI Goode has overall responsibility for BBSO, and all its instrumentation projects. Goode is also responsible for mentoring and leading scientific staff at BBSO in the CIRS Project, as well as coordinating between instrumental scientists, like Cao, and the CIRS Project. Goode and Coulter will work closely together on the CIRS Project, as they have on the NST. Goode spends half his time at BBSO.

### **A.4.1 Management Plan and Timelines**

During the building of the NST, we have assembled a strong instrumentation team at BBSO. The commissioning phase of the NST has just begun at this writing. As mentioned, if CIRS is funded several members of the NST team will be partly shifted to the CIRS project. The initial part of the implementation of CIRS will, in fact, be part of the commissioning phase since mounting structures need to be integrated with the light feed to the Coudé Lab AO system. Thus, we already have our team in place to do the proposed work and we risk losing essential BBSO staff and our momentum by delaying the start of the CIRS Project.

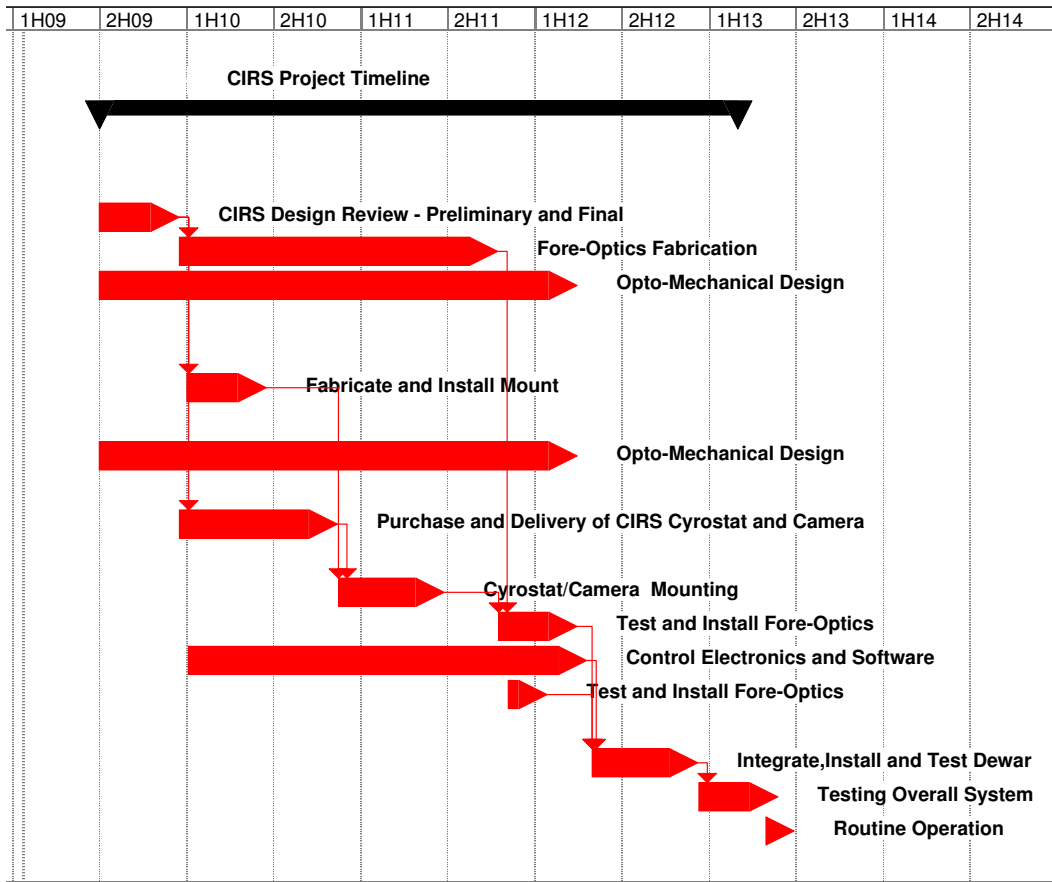

Figure 10: The Gantt Chart shows the CIRS project schedule, which is also detailed in Table 3. The CIRS Project runs for four years beginning mid-year 2009, and chart is divided into half-years.

In the Gantt chart in Figure 10 and in Table 3, we show the major proposed tasks of the CIRS project with timelines, as well as key personnel associated with the tasks. The Gantt chart sketches the CIRS tasks. Before CIRS, visible light and NIR NST observations at the Nasmyth focus will be on-going along with the afore mentioned AO construction. The first year of the CIRS Project will be used to refine designs, conduct the normal internal reviews and confirm those designs with IR Labs. Once the designs are finalized we will establish the construction contract for the dewar. The dewar and hardware for the Fore-Optics mount structure will be purchased during Year 1. In Year 2 the BBSO team will concentrate on producing the Fore-Optics hardware and software while the dewar and camera system are being built at IR Labs. Occasional visits to IR Labs will be used to track progress and stay abreast of any interface issues. Year 3 will see the completion and installation of the Fore-Optics System along with soft-

ware development and operational testing at the telescope. Once the dewar is delivered work will shift to installation of the optics in the dewar, initial alignment and operational testing of the dewar systems and camera controls. During Year 4 the project will culminate with final operational testing and installation at the telescope. Once test images are processed and approved the instrument will be brought online for observational use.

#### A.4.2 Hardware and Personnel Budget

The budget requested from NSF for the CIRS Project is \$1,314 K. The total budget is \$1,877 K, which includes a match of \$563 K from NJIT. As well, NJIT faculty and senior members of the CIRS Team will be working on the CIRS Project with no charge. The contribution here is difficult to know exactly, but it amounts to about 1 FTE. The largest equipment expenditure is \$772 K for the cryostat and 1-5  $\mu\text{m}$  camera (ALADDIN-II, InSb) and the mounting structure

Table 3: Tasks and Assignments for the CIRS Project.

Year	Task	Personnel
Year 1	Overall Management and Coordination	Goode
	Interface with IR Labs	R. Coulter, Gorceix and A. Coulter
	Opto-mechanical Design	R. Coulter, Gorceix and A. Coulter
	Design Review	Team plus IR Labs plus Don Mickey
	Fore-Optics Fabrication	Nenow
	External Fabrication Contracts	A. Coulter
	Install Fore-Optics Mount	A. Coulter, Nenow
Year 2	Overall Management and Coordination	Goode
	Interface with IR Labs	R. Coulter, Gorceix and A. Coulter
	Opto-mechanical Design	R. Coulter, Gorceix and A. Coulter
	Fore-Optics Fabrication	Nenow
	External Fabrication Contracts	A. Coulter
	Control Electronics	Abramenko, A. Coulter, and Shumko
	Control Software	Shumko, A. Coulter, and Abramenko
	Integration and testing Fore-Optics	R. Coulter, Gorceix, A. Coulter, Shumko and Graduate Student
Year 3	Overall Management and Coordination	Goode
	Opto-mechanical Design	R. Coulter, Gorceix and A. Coulter
	Fore-Optics Fabrication	Nenow
	External Fabrication Contracts	A. Coulter
	Control Electronics	Abramenko, A. Coulter, and Shumko
	Control Software	Shumko, A. Coulter, and Abramenko
	Integration and testing of Dewar	R. Coulter, Gorceix, A. Coulter, Shumko and Graduate Student
	Reduction of Test Data	Goode, Cao, Penn, Ayres and Graduate Student
Year 4	Overall Management and Coordination	Goode
	Control Electronics	Abramenko, A. Coulter, and Shumko
	Control Software	Shumko, A. Coulter, and Abramenko
	Integration and testing of Dewar	R. Coulter, Gorceix, A. Coulter, Shumko and Graduate Student
	Installation of Dewar	R. Coulter, Gorceix, A. Coulter, Shumko and Graduate Student
	Testing of Overall System	R. Coulter, Gorceix, A. Coulter, Shumko and Graduate Student
	Routine Operation	Observing Staff

for the system. This expenditure will be made in the first year after the final design review. In the second year, the internal and external optics of the CIRS will be purchased for a total of \$185 K (split \$114 K from the NSF and \$71 K from NJIT). The largest items here include the grating (\$39 K), the collimator (\$44 K), a series of filters and slits (\$65 K) and the remaining items are individually less than \$10 K. In the third year, we will spend a total of \$75 K split between the tip/tilt stage (\$45 K) and Dalsa Camera (\$30 K) for the correlation tracker system. There are no equipment purchases in the fourth and final year of the project.

The remainder of the budget is dominated by per-

sonnel costs of about one FTE per year over the four year project. As well, NJIT will match with about three-quarters of an FTE per year. Over the length of the project, NJIT will match with two months per year of co-PI Roy Coulter's time and thirteen months (over the project) of Nicolas Gorceix's time. Coulter will manage and coordinate the diverse elements of the project and oversee the optical and mechanical design and operation of the system. Nicolas Gorceix, the BBSO optical engineer, will complete the CIRS optical design, identify vendors, oversee purchasing and assist with integration and testing. Coulter and Gorceix have already made the strawman de-



sign of CIRS. Prof. Wenda Cao is an expert in instrumentation and spectrographs, in particular. Cao will work closely with Coulter and Gorceix. As well, Matt Penn, Thomas Ayres and Phil Goode charge no time to the project, but will work to ensure the success of the CIRS Project. Penn leads the IR instrumentation efforts at the McMath-Pierce telescope and Ayres is an expert in both the NIR and spectroscopic efforts to explore that spectral regime. They will be critical in ensuring optimal possible specifications are identified and met are met by CIRS. Goode has overall responsibility for BBSO and will coordinate efforts among the commissioning efforts of the NST, including CIRS. Cao and Goode will be responsible for the PhD students who will work, in part on CIRS, and be supported by BBSO's current five-year "backbone" NSF grant that is in its first year and Cao's five year NSF Career Award that is just beginning. The effort of these personnel will be focussed on all aspects of implementing the CIRS system. co-PI Roy Coulter will oversee training of observing staff and production of documentation, maintenance, and user manuals.

We request funds to support 3.5 FTE's of engineers over the length of the four year CIRS project. This includes six months of time of BBSO's electronic engineer, Vlad Abramenko, will design and build the electronic interfaces and control hardware; and ten months of time of Sergey Shumko to handle all high level software included interfacing CIRS to the NST Telescope Control System and participate in integration, testing and initial operations of CIRS; and ten months of mechanical engineer Jeff Nenow's time to be responsible for on-site fabrication and assist with assembly; and finally sixteen months of mechanical engineer Aaron Coulter's time to be responsible for mechanical design, outside fabrication contracts, machine control, along with integration and testing.

The travel budget is primarily for collaborating personnel travel between BBSO, NSO/T and CU.

The team is lean, but has already demonstrated its prowess on the the NST project.